

TOSHIBA PHOTOCOUPLER PHOTO RELAY

TLP225A

PROGRAMMABLE CONTROLLERS

I/O BOARD INTERFACE

DC-OUTPUT MODULE

REPLACEMENT FOR DC MECHANICAL RELAY

The TOSHIBA TLP225A consist of a gallium arsenide infrared emitting diode optically coupled to a photo-MOS FET in a four lead plastic DIP package (DIP4).

(The TLP225A is MOSFET output and can control a current of 0.5 A which is suitable for DC output module.)

- Peak Off-State Voltage : 60 V (Min.)
- Trigger LED Current : 5 mA (Max.)
- On-State Current : 500 mA (Max.)
- On-State Resistance : 1.1 Ω (Max.)
- Isolation Voltage : 2500 Vrms (Min.)
- UL Recognized : UL1577, File No. E67349

Unit in mm

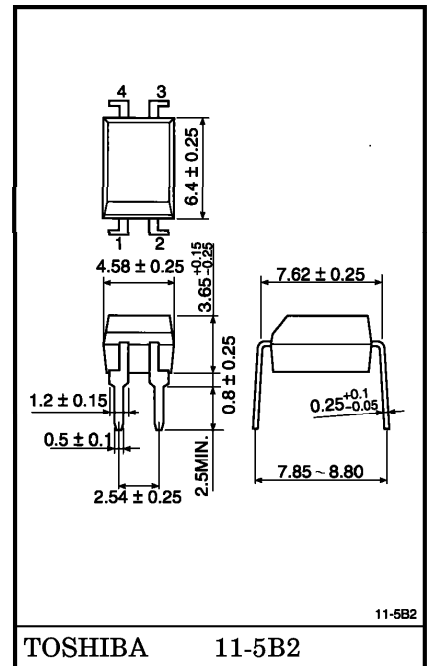

TOSHIBA 11-5B2

Weight : 0.27 g

PIN CONFIGURATION (TOP VIEW)

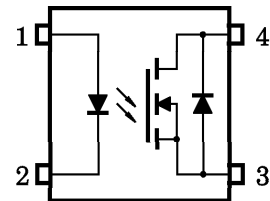

- 1 : ANODE
- 2 : CATHODE
- 3 : SOURCE
- 4 : DRAIN

MAXIMUM RATINGS (Ta = 25°C)

CHARACTERISTIC		SYMBOL	RATING	UNIT
LED	Forward Current	I_F	50	mA
	Forward Current Derating (Ta ≥ 53°C)	$\Delta I_F / ^\circ\text{C}$	-0.5	mA / °C
	Peak Forward Current (100 μs pulse, 100 pps)	I_{FP}	1	A
	Reverse Voltage	V_R	5	V
	Junction Temperature	T_j	125	°C
DETECTOR	Off-State Output Terminal Voltage	V_{OFF}	60	V
	On-State Current	I_{ON}	500	mA
	On-State Current Derating (Ta ≥ 25°C)	$\Delta I_{ON} / ^\circ\text{C}$	-5.0	mA / °C
	Junction Temperature	T_j	125	°C
Storage Temperature Range		T_{stg}	-55~125	°C
Operating Temperature Range		T_{opr}	-20~85	°C
Lead Soldering Temperature (10 s)		T_{sol}	260	°C
Isolation Voltage (AC, 1min., R.H. ≤ 60%) (Note 1)		BVS	2500	Vrms

(Note 1) : Pins 1 and 2 shorted together and pins 3 and 4 shorted together.

RECOMMENDED OPERATING CONDITIONS

CHARACTERISTIC	SYMBOL	MIN.	TYP.	MAX.	UNIT
Supply Voltage	V_{DS}	—	—	48	V
Forward Current	I_F	12	20	30	mA
Collector Current	I_{ON}	—	—	300	mA
Operating Temperature	T_{opr}	-20	—	60	°C

INDIVIDUAL ELECTRICAL CHARACTERISTICS (Ta = 25°C)

CHARACTERISTIC		SYMBOL	TEST CONDITION	MIN.	TYP.	MAX.	UNIT
LED	Forward Voltage	V_F	$I_F = 10 \text{ mA}$	1.0	1.15	1.3	V
	Reverse Current	I_R	$V_R = 5 \text{ V}$	—	—	10	μA
	Capacitance	C_T	$V = 0, f = 1 \text{ MHz}$	—	30	—	pF
DETECTOR	Off-State Current	I_{OFF}	$V_{OFF} = 60 \text{ V}$	—	—	1	μA
	Capacitance	C_{OFF}	$V = 0, f = 1 \text{ MHz}$	—	—	—	pF

COUPLED ELECTRICAL CHARACTERISTICS (Ta = 25°C)

CHARACTERISTIC	SYMBOL	TEST CONDITION	MIN.	TYP.	MAX.	UNIT
Trigger LED Current	I_{FT}	$I_{ON} = 500 \text{ mA}$	—	3	5	mA
On-State Resistance	R_{ON}	$I_{ON} = 500 \text{ mA}, I_F = 10 \text{ mA}$	—	0.8	1.1	Ω

ISOLATION CHARACTERISTICS (Ta = 25°C)

CHARACTERISTIC	SYMBOL	TEST CONDITION	MIN.	TYP.	MAX.	UNIT
Capacitance Input to Output	C_S	$V_S = 0, f = 1 \text{ MHz}$	—	0.8	—	pF
Isolation Resistance	R_S	$V_S = 500 \text{ V}, \text{R.H.} \leq 60\%$	5×10^{10}	10^{14}	—	Ω
Isolation Voltage	BV_S	AC, 1 minute	2500	—	—	Vrms
		AC, 1 second, in oil	—	5000	—	—
		DC, 1 minute, in oil	—	5000	—	—

SWITCHING CHARACTERISTICS (Ta = 25°C)

CHARACTERISTIC	SYMBOL	TEST CONDITION	MIN.	TYP.	MAX.	UNIT
Turn-on Time	t_{ON}	$R_L = 200 \Omega$ (Note 2)	—	—	2	ms
Turn-off Time	t_{OFF}	$V_{DS} = 20 \text{ V}, I_F = 10 \text{ mA}$	—	—	2	

(Note 2) : SWITCHING TIME TEST CIRCUIT

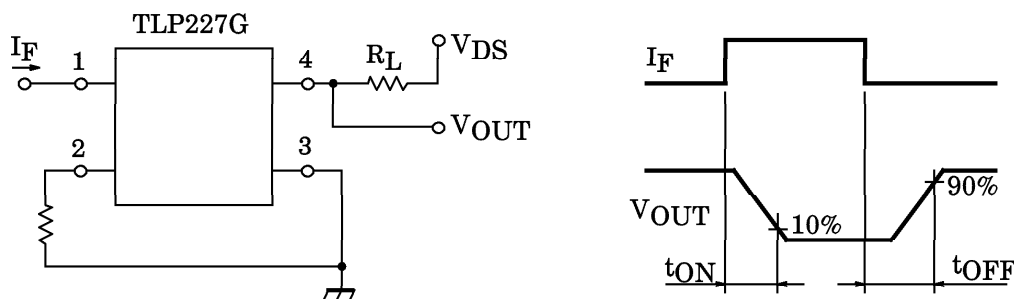

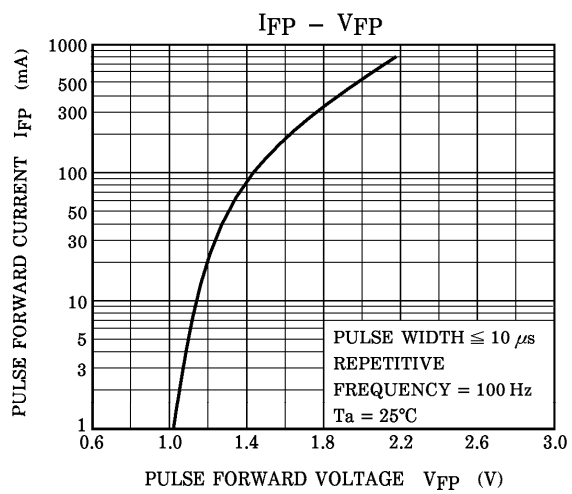
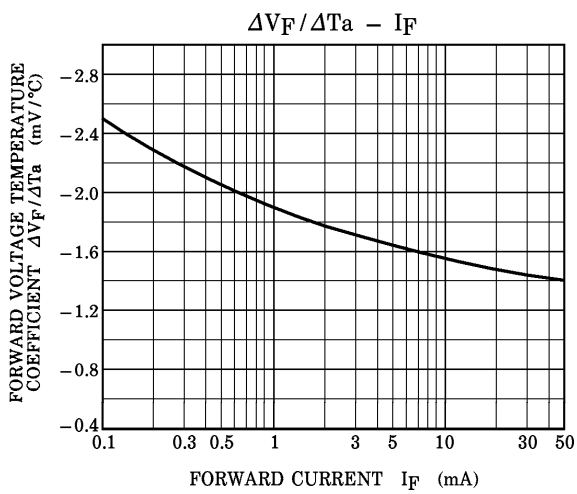
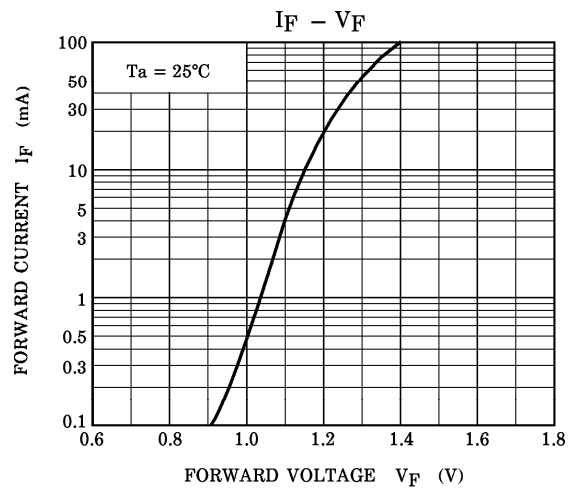
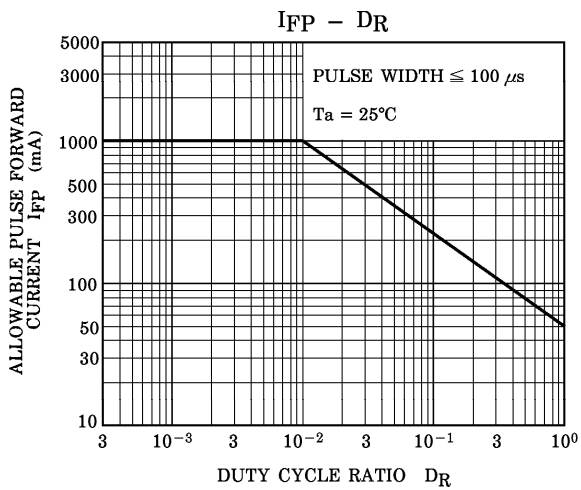
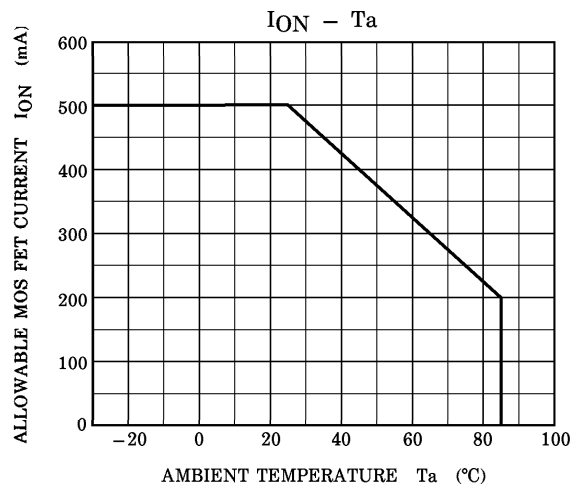
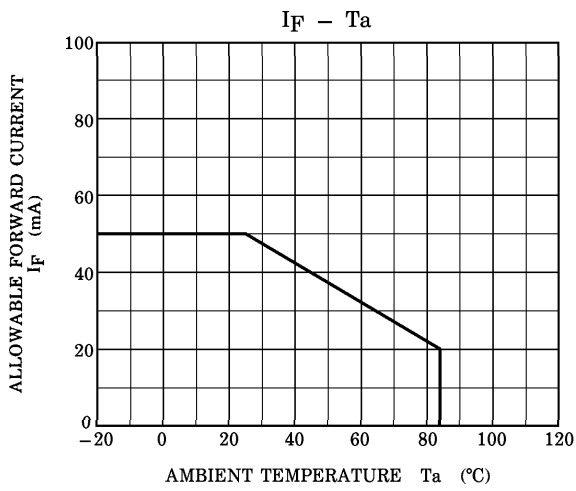

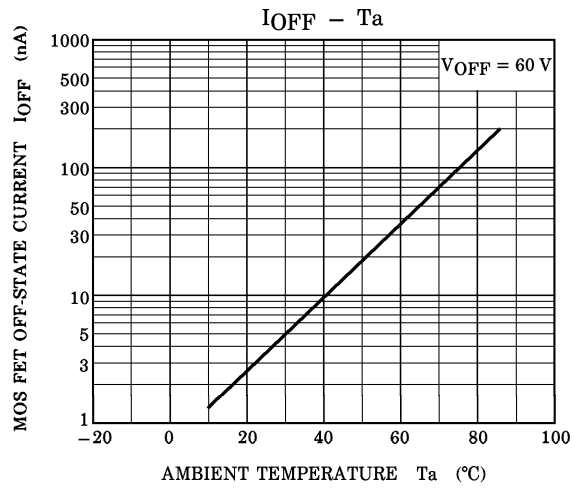
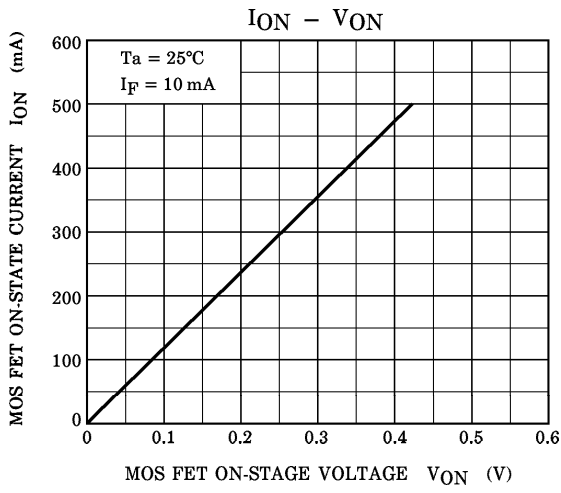

RESTRICTIONS ON PRODUCT USE

000707EBC

- TOSHIBA is continually working to improve the quality and reliability of its products. Nevertheless, semiconductor devices in general can malfunction or fail due to their inherent electrical sensitivity and vulnerability to physical stress. It is the responsibility of the buyer, when utilizing TOSHIBA products, to comply with the standards of safety in making a safe design for the entire system, and to avoid situations in which a malfunction or failure of such TOSHIBA products could cause loss of human life, bodily injury or damage to property. In developing your designs, please ensure that TOSHIBA products are used within specified operating ranges as set forth in the most recent TOSHIBA products specifications. Also, please keep in mind the precautions and conditions set forth in the "Handling Guide for Semiconductor Devices," or "TOSHIBA Semiconductor Reliability Handbook" etc..
- The TOSHIBA products listed in this document are intended for usage in general electronics applications (computer, personal equipment, office equipment, measuring equipment, industrial robotics, domestic appliances, etc.). These TOSHIBA products are neither intended nor warranted for usage in equipment that requires extraordinarily high quality and/or reliability or a malfunction or failure of which may cause loss of human life or bodily injury ("Unintended Usage"). Unintended Usage include atomic energy control instruments, airplane or spaceship instruments, transportation instruments, traffic signal instruments, combustion control instruments, medical instruments, all types of safety devices, etc.. Unintended Usage of TOSHIBA products listed in this document shall be made at the customer's own risk.
- Gallium arsenide (GaAs) is a substance used in the products described in this document. GaAs dust and fumes are toxic. Do not break, cut or pulverize the product, or use chemicals to dissolve them. When disposing of the products, follow the appropriate regulations. Do not dispose of the products with other industrial waste or with domestic garbage.
- The products described in this document are subject to the foreign exchange and foreign trade laws.
- The information contained herein is presented only as a guide for the applications of our products. No responsibility is assumed by TOSHIBA CORPORATION for any infringements of intellectual property or other rights of the third parties which may result from its use. No license is granted by implication or otherwise under any intellectual property or other rights of TOSHIBA CORPORATION or others.
- The information contained herein is subject to change without notice.